

# GALERIEBLENDEN

---

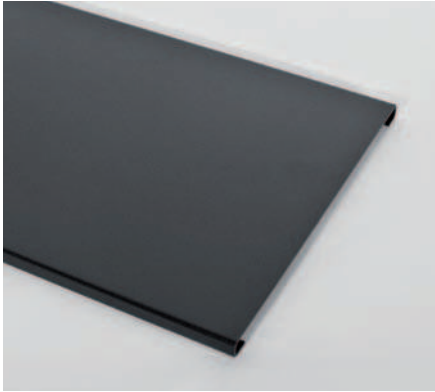



**GALERIEBLENDEN  
 TYP 1**

**AUFMASS**

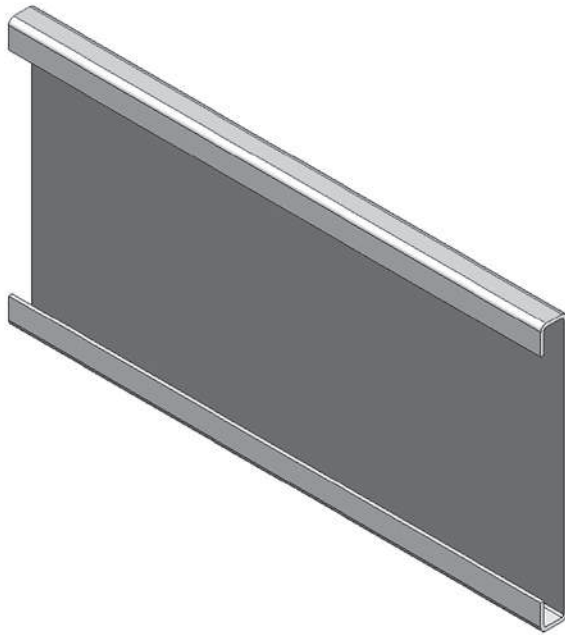
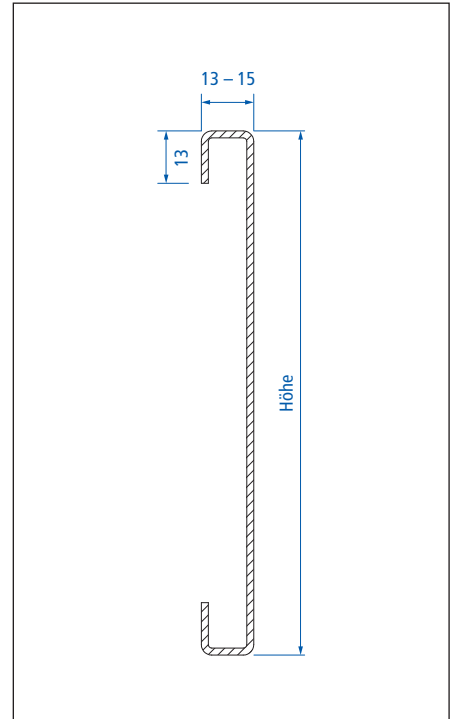

**GEHRUNG**

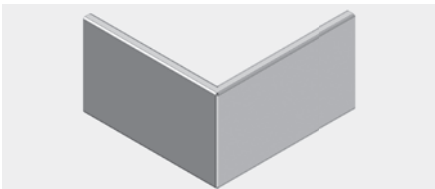

Gehung aussen

**SEITENTEIL**

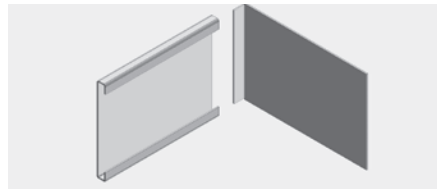

Seitenteil

**DILA**

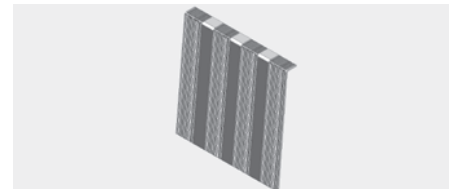

Dila

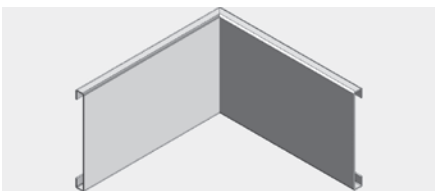

Gehung innen

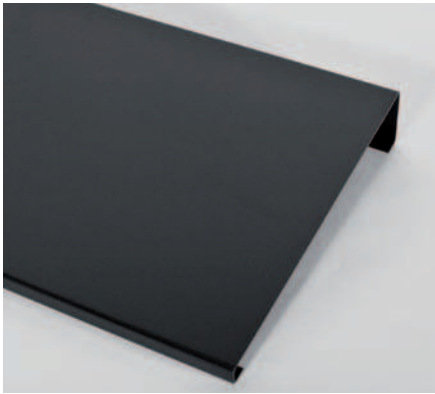

## GALERIEBLENDEN TYP 5

### AUFMASS

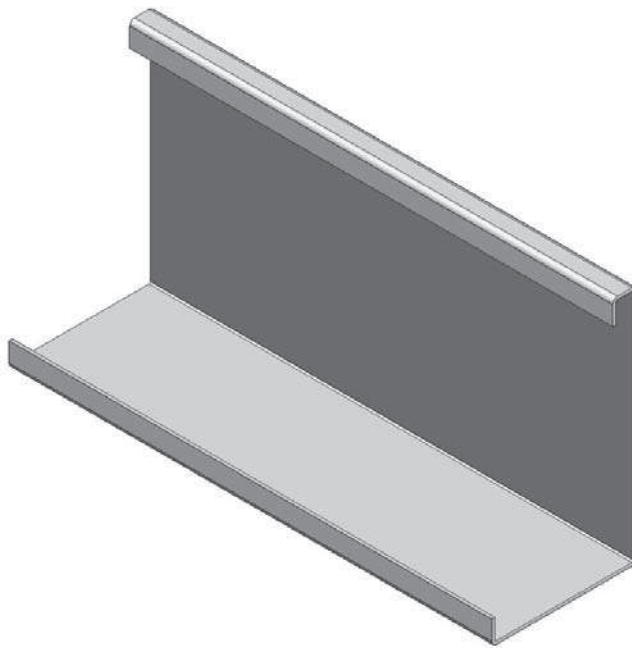
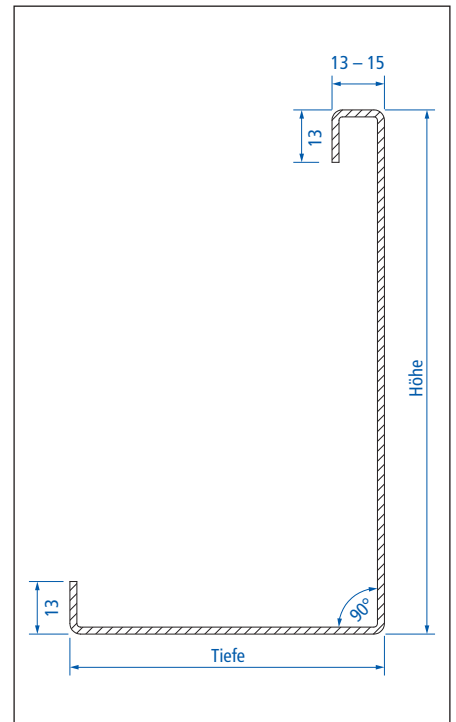

### GEHRUNG

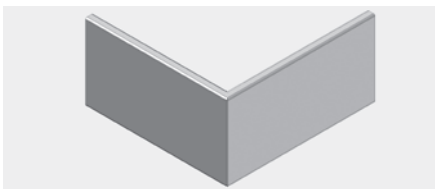

Gehung aussen

### SEITENTEIL

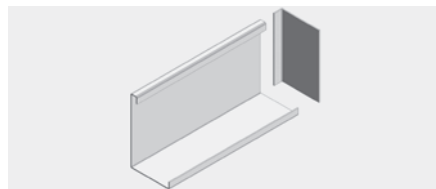

Seitenteil

### DILA

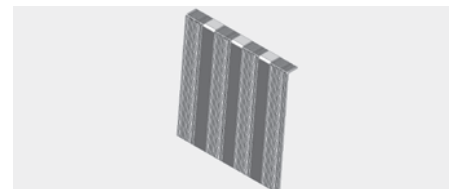

Dila

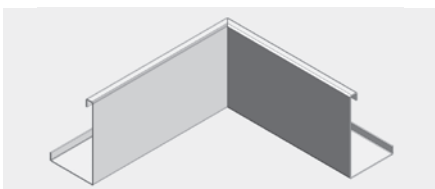

Gehung innen

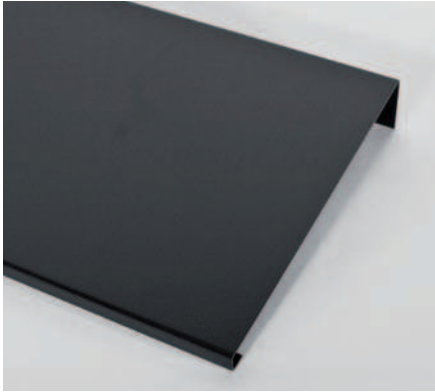

**GALERIEBLENDEN  
TYP 6**

**AUFMASS**

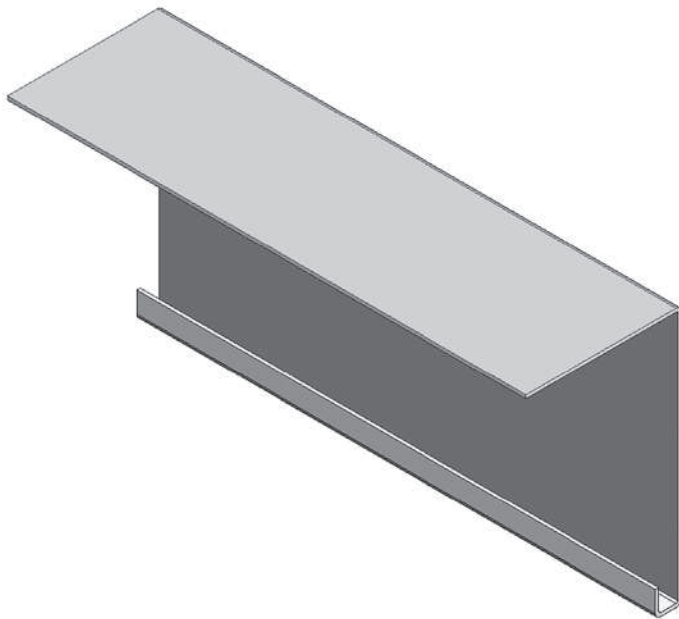
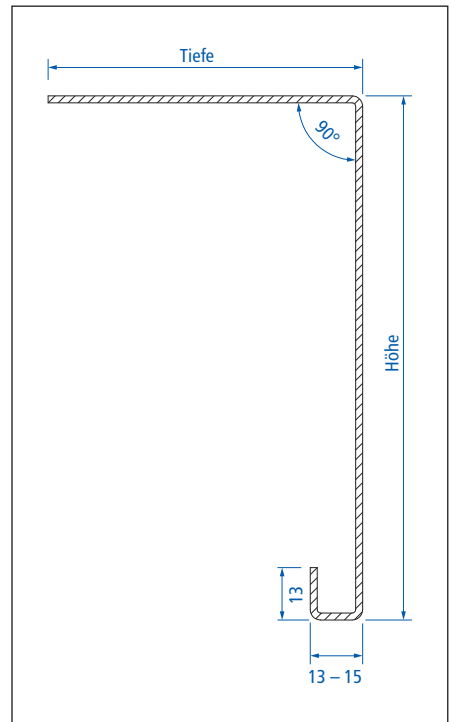

**GEHRUNG**

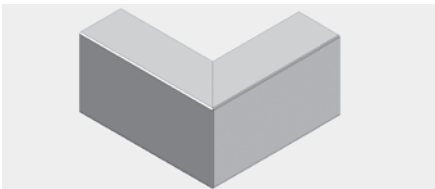

Gehrung aussen

**SEITENTEIL**

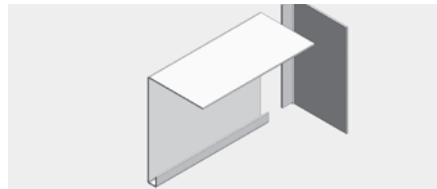

Seitenteil

**DILA**

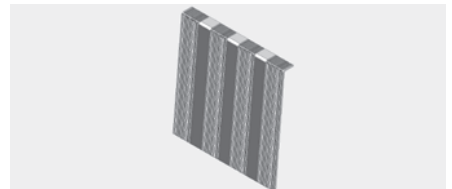

Dila

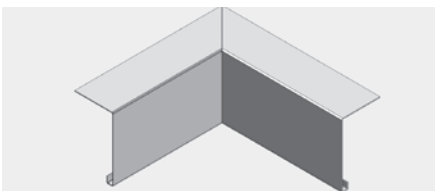

Gehrung innen





## GALERIEBLENDEN TYP 8

### AUFMASS

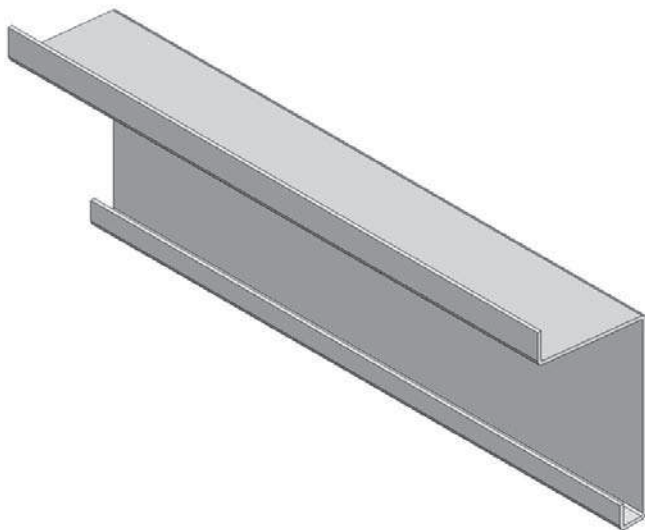
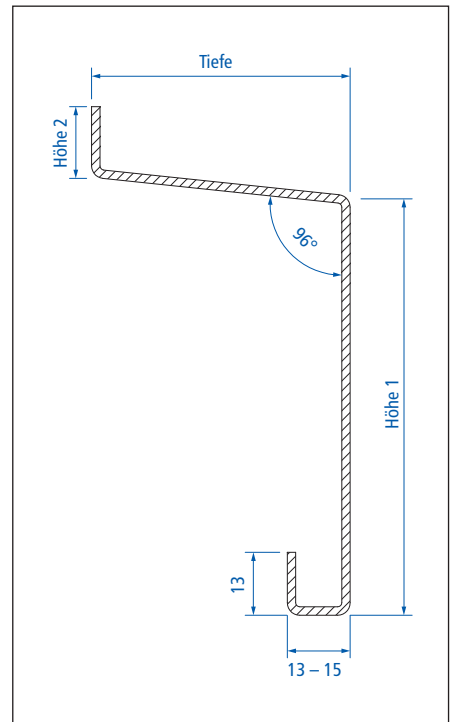

### GEHRUNG

### SEITENTEIL

### DILA

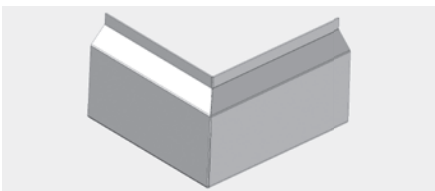

Gehrung aussen

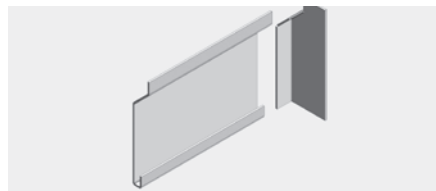

Seitenteil

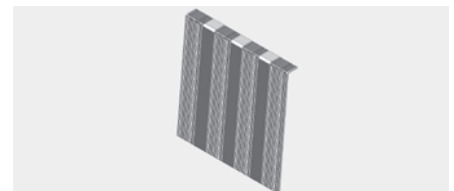

Dila

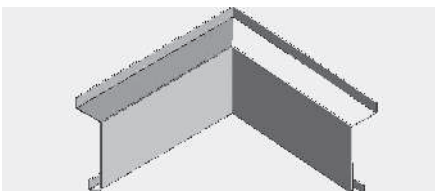

Gehrung innen



Galerieblende Typ 1, eloxiert

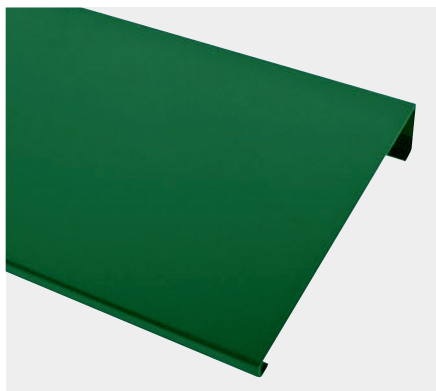

Galerieblende Typ 5, einbrennlackiert



Galerieblende Typ 6, einbrennlackiert



Galerieblende Typ 8, eloxiert